

SFIX CHART

SFIX No.	COUNTRY	VOLTAGE	FREQUENCY (Hz)	PAPER SIZE	SFIX No.	COUNTRY	VOLTAGE	FREQUENCY (Hz)	PAPER SIZE
011	JAPAN (magicolor 2300DL)	100V	50/60	METRIC	213	ASIA (magicolor 2300DL)	220V	50	METRIC
012	JAPAN (magicolor 2350)	100V	50/60	METRIC	311	USA/CANADA (magicolor 2300DL)	110V	60	INCH
211	EUROPE (magicolor 2300DL)	220V	50	METRIC	312	USA/CANADA (magicolor 2350)	110V	60	INCH
212	EUROPE (magicolor 2350)	220V	50	METRIC					

CONTENTS 目次

1.	HOUSING	1
2.	TRANSPORT SECTION	3
3.	RACK/TRANSFER SECTION	5
4.	DRIVE SECTION (A)	7
5.	DRIVE SECTION (B)	9
6.	ELECTRICAL COMPONENTS	11
7.	FUSING/PAPER EXIT SECTION	13
8.	FRAMES	15
9.	PAPER TRANSPORT SECTION	17
10.	PAPER TAKE-UP SECTION	19
11.	FRAMES (OPTION)	21
12.	PAPER TRAY UNIT (OPTION)	23
13.	DUPLEX UNIT (OPTION)	25
14.	WIRING ACCESSORIES AND JIGS	27
15.	SCREWS AND WASHERS	29
16.	NUMERICAL INDEX	30

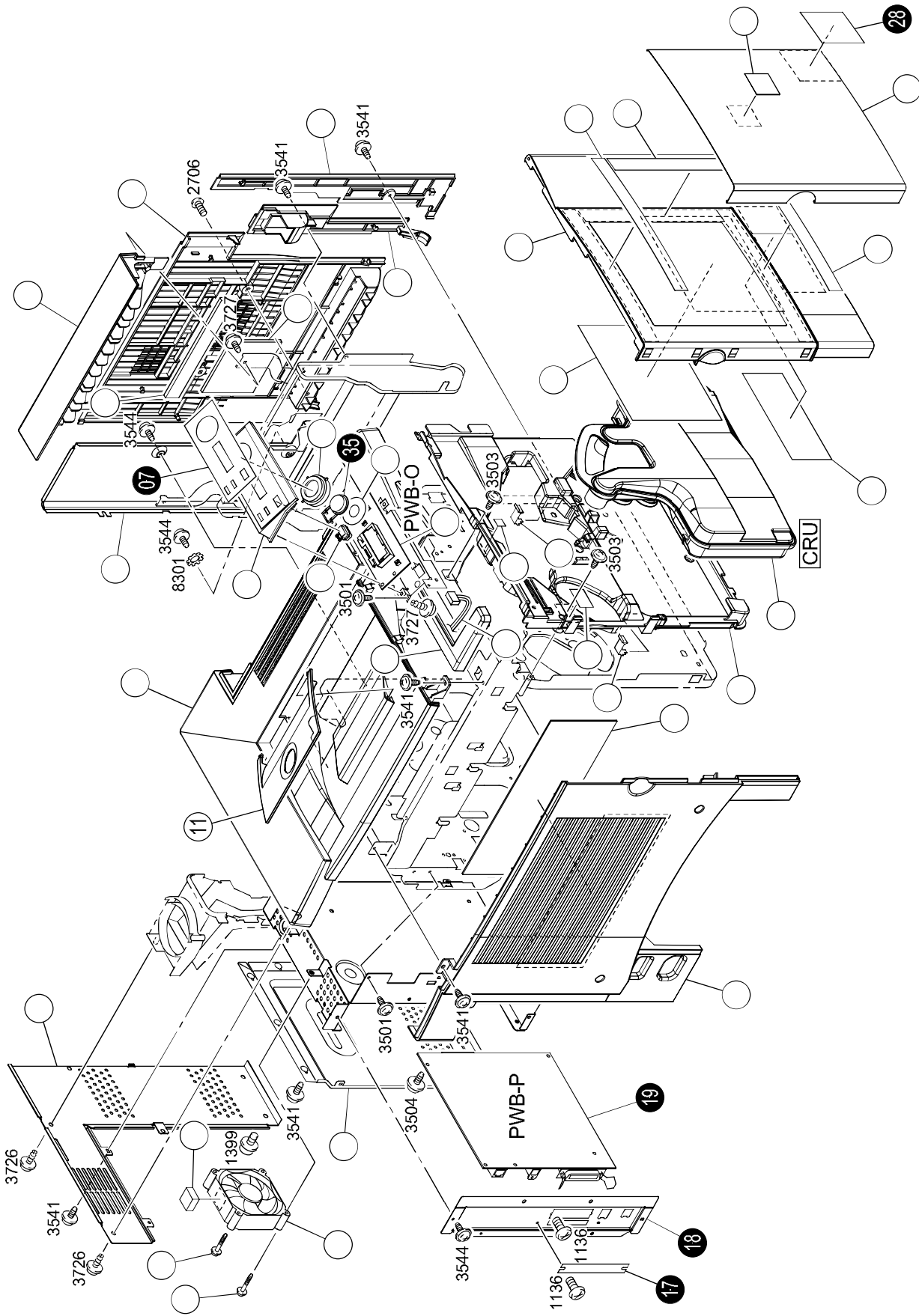

INDEX	PART NO.	PART NAME	REC	QTY	INDEX	PART NO.	PART NAME	REC	QTY
01	4131-1013-03	RIGHT COVER 右カバー		1	23	4131-1030-06	COVER カバー		1
02	4131-1010-07	RIGHT COVER 右カバー		1	24	4337-110	BOTTLE 瓶		1
03	4131-1006-04	RIGHT COVER 右カバー		1	25	4131-7427-01	BOX (M.G.I.) 箱	(CRU)	1
04	4131-1011-05	RIGHT COVER 右カバー		1	26	4131-1026-01	MATING MEMBER 嵌合部材		3
05	4131-3622-01	FILTER フィルター		1	27	4131-1005-01	COVER カバー		1
06	4131-1024-01	SEAL シール		1	29	4120-7362-01	LABEL ラベル		1
08	4131-1007-03	RIGHT COVER 右カバー		1	30	4131-1002-05	FRONT COVER 前カバー		1
09	4131-1110-02	PANEL パネル		1	31	4131-7401-01	LABEL ラベル		1
10	4131-1001-06	TOP COVER 上カバー		1	32	4131-7414-01	LABEL ラベル		1
11	4131-1012-04	TRAY トレイ		1	33	4131-0105-03	PWB ASSY 基板 ASSY	(PWB-O)	1
12	4131-1008-03	REAR COVER 後カバー		1	34	4131-1117-01	SHIELD シールド		1
13	4131-2322-01	SOUND SHIELD 防音材		1	36	4131-1113-02	BUTTON ボタン		1
14	4131-2350-01	SCREW ねじ		2	37	4131-1114-02	BUTTON ボタン		1
15	9313-1100-41	FAN MOTOR ファンモーター		1	38	4131-1101-03	COVER カバー		1
16	4131-1009-02	COVER カバー	RP	1	39	4131-6836-02	WIRE HARNESS ASSY ハーネス ASSY		1
20	4131-1003-05	LEFT COVER 左カバー		1	40	4131-7425-01	LABEL ラベル		1
21	4131-1025-01	FILTER フィルター		1					
22	4131-4702-03	PLATE SPRING 板ばね		2					
SFIX									
INDEX	PART NO.	PART NAME	REC	QTY	INDEX	PART NO.	PART NAME	REC	QTY
07	4131-1118-02	PANEL SHEET パネルシート		1	211, 212, 213, 311, 312				
07	4131-1119-02	PANEL SHEET パネルシート		1	011, 012				
17	4131-2357-01	COVER カバー		1	012, 212, 312				
18	4131-2354-02	BRACKET 取付板		1	011, 211, 213, 311				
18	4131-2356-01	BRACKET 取付板		1	012, 212, 312				
19	4131-6006-04	PWB ASSY 基板 ASSY	RP	1	011, 211, 213, 311				
19	4131-6007-01	PWB ASSY 基板 ASSY	RP	1	212, 312				
28	4131-7322-01	LABEL ラベル		1	011, 211, 213, 311				
28	4131-7323-02	LABEL ラベル		1	012, 212, 312				
35	4131-1112-03	BUTTON ボタン		1	211, 212, 213, 311, 312				
35	4131-1115-02	BUTTON ボタン		1	011, 012				

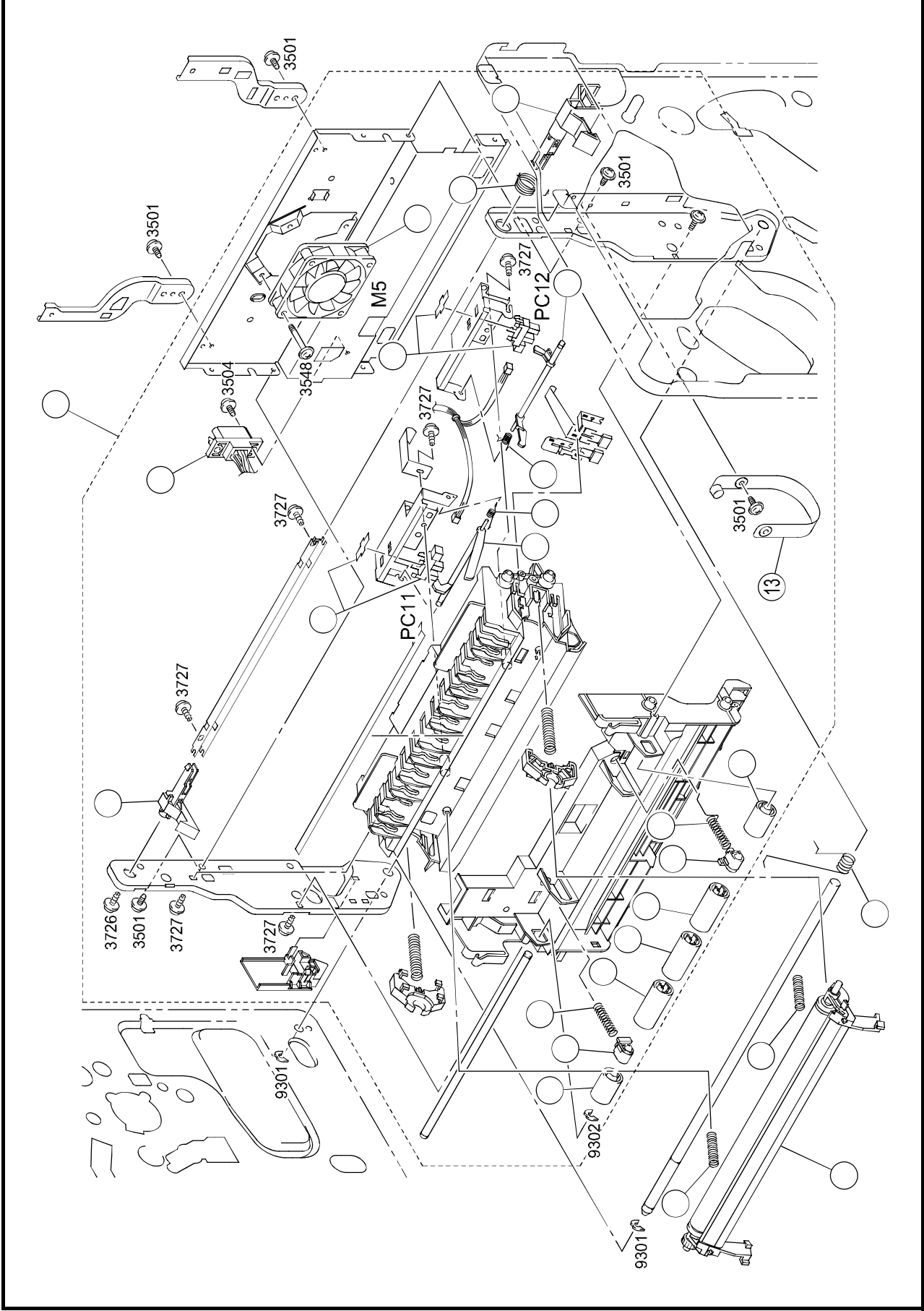

INDEX	PART NO.	PART NAME	REC	QTY	INDEX	PART NO.	PART NAME	REC	QTY
01	4131-0365-06	SIDE OPEN ASSY 側開 解明	RP	1	19	4131-4052-01	PRESSURE SPRING 圧縮コイルばね		2
02	4131-6820-01	WIRE HARNESS ASSY ハーネスアッシー	RP	1	20	4131-0370-03	AND TRANSFER ROLLER ASSY 2次転写ローラー	RP	1
03	4131-3607-01	PAWL 爪		1					
04	4131-0902-01	PHOTO INTERLUPTER フォトインタラプター		2					
05	9313-1100-51	FAN MOTOR ファンモーター		1					
06	4131-3604-01	TORSION SPRING ねじりコイルばね		1					
07	4131-3606-05	PAWL 爪		1					
08	4131-3618-01	ACTUATOR アクチュエーター		1					
09	4131-3619-02	TORSION SPRING ねじりコイルばね		1					
10	4131-3628-01	TORSION SPRING ねじりコイルばね		1					
11	4131-3626-02	ACTUATOR アクチュエーター		1					
12	4131-3630-02	TORSION SPRING ねじりコイルばね		1					
13	4131-3610-02	BAND バンド		1					
14	4131-3541-01	ROLL ロール		2					
15	4131-3537-03	BUSHING 軸受		2					
16	4131-3539-02	PRESSURE SPRING 圧縮コイルばね		1					
17	4131-3535-01	ROLL ロール		3					
18	4131-3540-02	PRESSURE SPRING 圧縮コイルばね		1					

INDEX	PART NO.	PART NAME	REC	QTY	INDEX	PART NO.	PART NAME	REC	QTY
							SFIX		

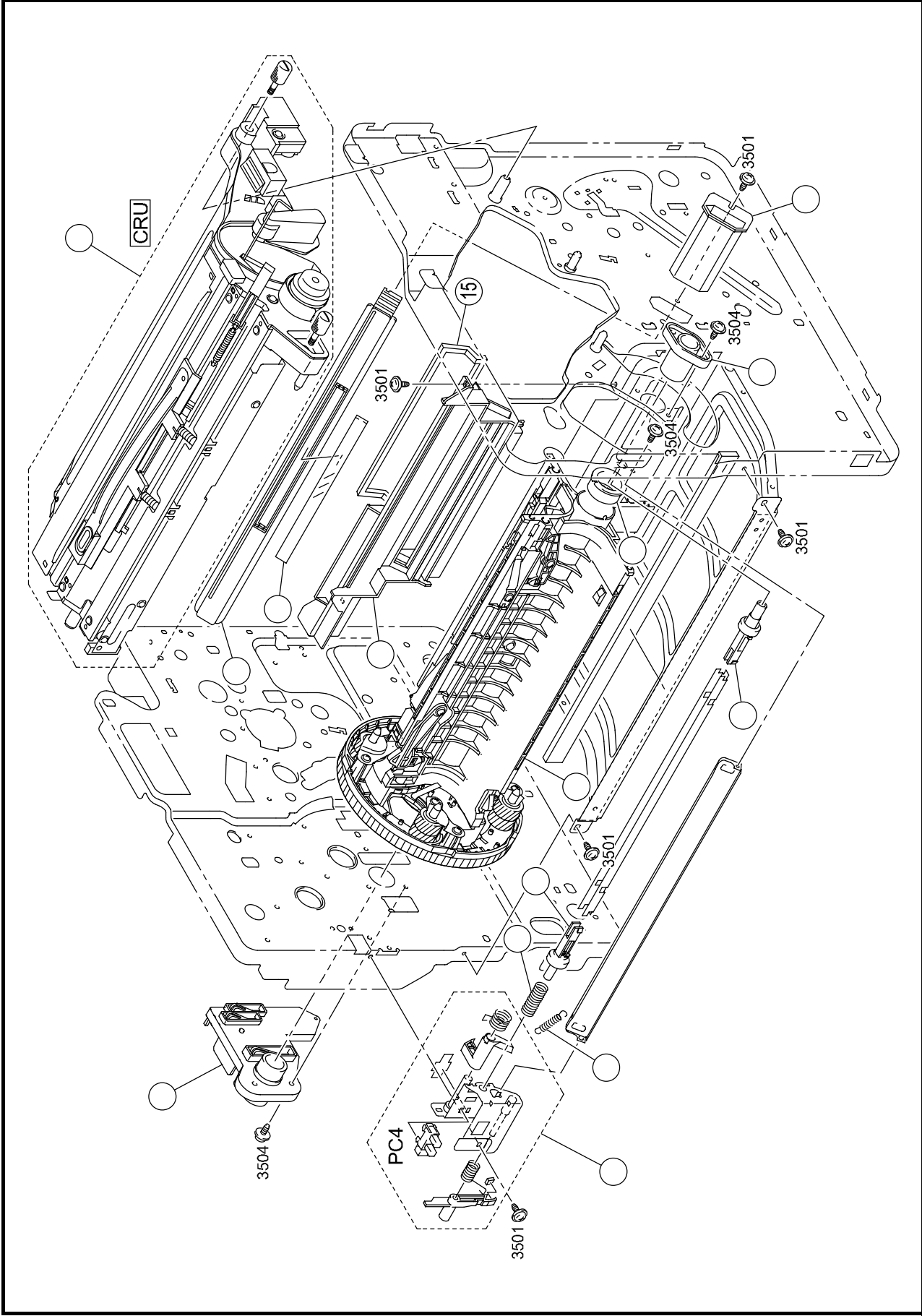

INDEX	PART NO.	PART NAME	REC	QTY	INDEX	PART NO.	PART NAME	REC	QTY
01	4337-210	TRANSFER ASSY 中間転写 (MQ I)	RP	1					
02	4131-2015-02	FILTER フィルタ		1					
03	4131-2012-03	HOLDER ホルダ		1					
04	4131-2009-02	COVER カバー		1					
05	4131-0398-01	HOLDER ASSY H.V. 基板 A S S Y		1					
06	4131-0341-02	LOCK LEVER ASSY ロックレバー	RP	1					
07	4131-2988-01	TENSION SPRING 引張コイルばね		1					
08	4131-2984-01	PRESSURE SPRING 圧縮コイルばね		1					
09	4131-2986-02	HOLDER ホルダ		1					
10	4131-0316-02	RACK ASSY ラック		1					
11	4131-2983-02	HOLDER ホルダ		1					
12	4131-2705-01	COLLAR カラー		1					
13	4131-2710-02	SHAFT シャフト		1					
14	4131-2011-01	RAIL レール		1					
15	4131-2013-02	SEAL シール		1					
INDEX	PART NO.	PART NAME	REC	QTY			PART NAME	REC	QTY
							SFIX		

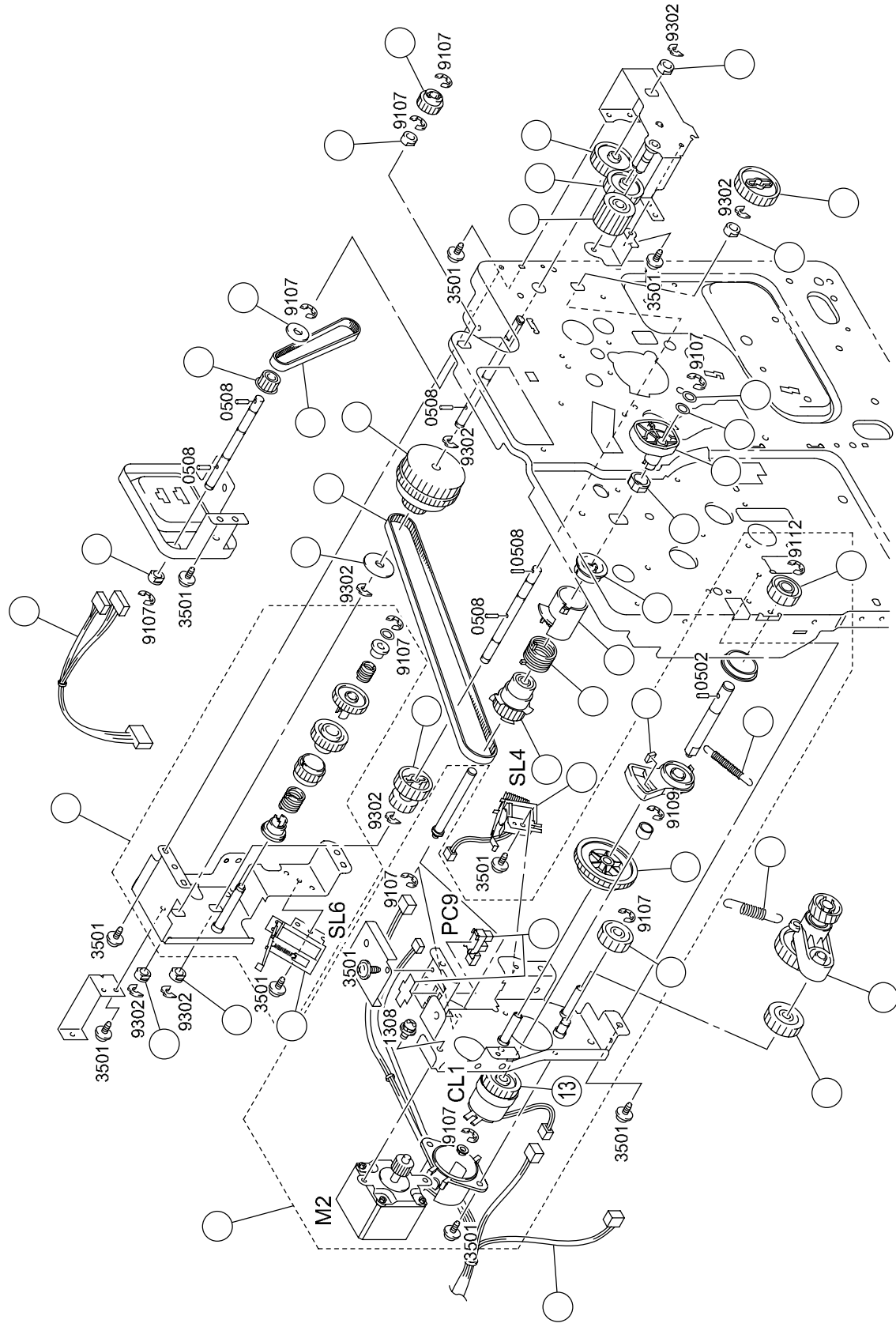

INDEX	PART NO.	PART NAME	REC	QTY	INDEX	PART NO.	PART NAME	REC	QTY	INDEX	PART NO.	PART NAME	REC	QTY
01	4131-2596-01	GEAR ギヤ		1	19	4131-2602-02	GEAR ギヤ		1	20	4120-1213-02	TENSION SPRING ねじりコイルばね		1
02	1200-3121-07	BUSHING クワケ		6	21	4131-2611-01	FLANGE フランジ		1	22	4131-2805-01	SOUND SHIELD 防音板	RP	1
03	4131-2535-01	FLANGE フランジ		1	23	4131-2561-01	PULLEY プーリー		1	24	4131-2571-01	GEAR ギヤ	RP	1
04	4131-2595-01	PULLEY プーリー		1	25	4131-2564-02	TORSION SPRING ねじりコイルばね		1	26	4131-2563-02	RATCHET ラatchet	RP	1
05	4131-0151-01	DRIVING ASSY 駆動 A S S Y		1	27	4131-2592-14	DRUM ドラム	RP	1	28	4131-2589-01	BUSHING 軸受け	RP	1
06	4131-2599-01	TIMING BELT タイミンクベルト		1	29	4131-2562-14	CAM カム	RP	1	30	1200-1342-05	WASHER ワッシャー		2
07	4131-2560-01	FLANGE フランジ		1	31	4131-2559-01	GEAR ギヤ		1	32	4131-2553-01	GEAR ギヤ		1
08	4131-6832-02	WIRE HARNESS ASSY ハーネス A S S Y		1	33	4131-2552-01	GEAR ギヤ		1	34	4131-2549-02	GEAR ギヤ		1
09	4131-0355-02	FUSING DECELERATION UNIT 定着減速駆動		1	35	4131-2593-01	TIMING BELT タイミンクベルト		1	36	9321-2100-41	CLEANER クリーナー	(SL4)	1
10	9321-2100-61	SOLENOID ソレノイド		1			FLUSHING 定着ループ	(SL6)	1					
11	4131-0302-01	RACK DRIVE ASSY ラック駆動 A S S Y		1			RACK ラック	(OLI)	1					
12	4131-6811-03	WIRE HARNESS ASSY ハーネス A S S Y		1			CLEANER クリーナー位置	(PC9)	1					
13	9322-1200-11	CLUTCH クラッチ		1					1					
14	4131-0902-01	PHOTO INTERRUPTER フォトインタラプター		1					1					
15	4131-2615-01	GEAR ギヤ		1					1					
16	4131-2608-01	GEAR ギヤ		1					1					
17	4131-0752-01	LEVER ASSY レバアサンプ		1					1					
18	4131-2621-01	TENSION SPRING ねじりコイルばね		1					1					
INDEX	PART NO.	PART NAME	REC	QTY	SFIX									

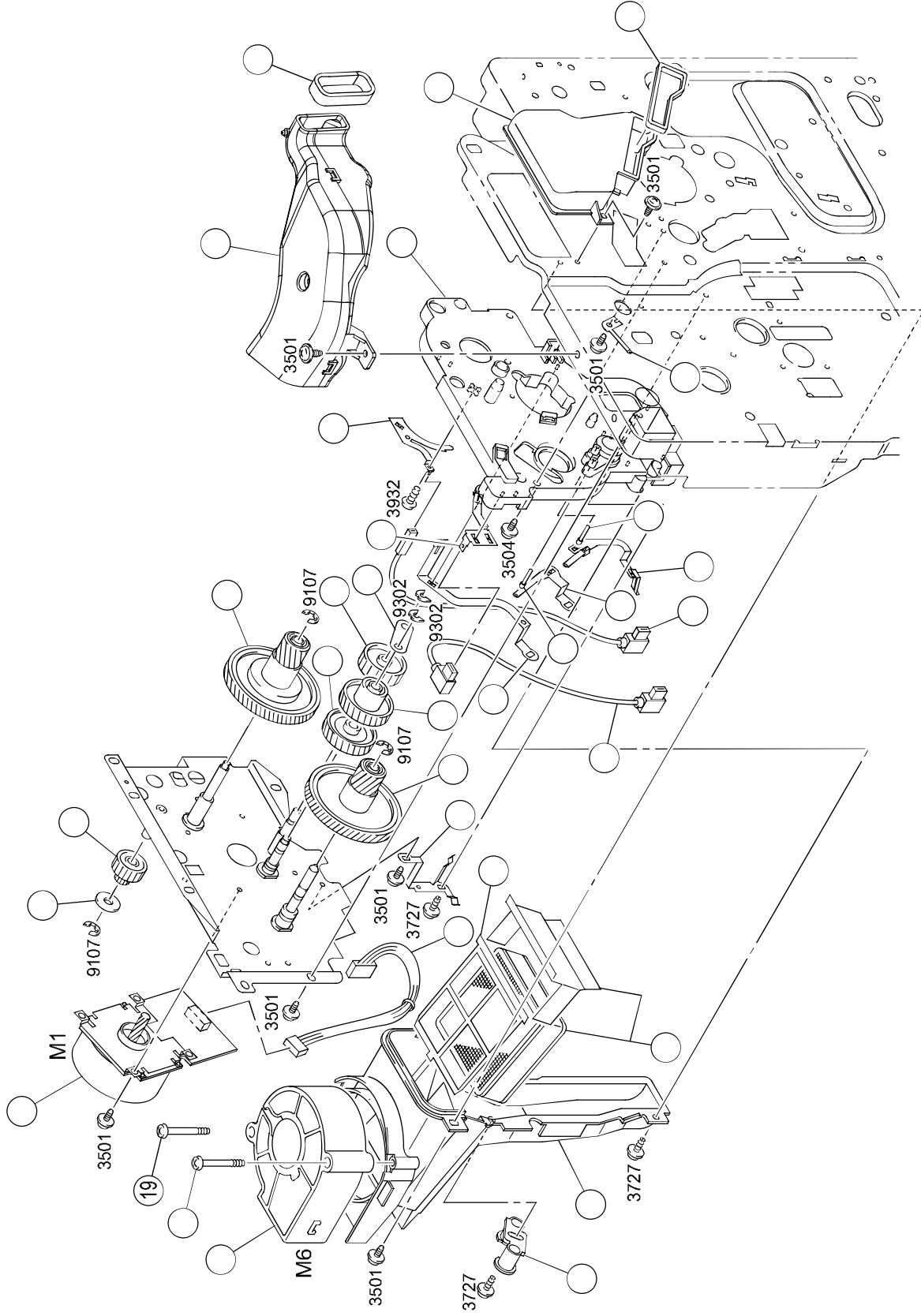

INDEX	PART NO.	PART NAME	REC	QTY	INDEX	PART NO.	PART NAME	REC	QTY
01	4131-3943-01	SEAL シール		1	19	1151-4524-01	TAPPING SCREW タッピングネン		1
02	4131-0152-01	DUCT ASSY ダクトアサシ		1	20	9313-1100-31	FAN MOTOR ファンモータ	VENTILATION (M6) 排気	2
03	4131-2585-01	CONTACT 接点		1	21	4131-4635-02	GUIDE ガイド		1
04	4131-4609-01	DUCT ダクト		1	22	4131-4631-04	DUCT ダクト		1
05	4131-4612-01	SEAL シール		1	23	4131-0906-01	FILTER KIT フィルタキット		1
06	4131-2583-01	EARTH GROUND アース		1	24	4131-6813-01	WIRE HARNESS ASSY ワイヤアサシ		1
07	4131-2580-03	HOLDER ホルダ		1	25	4131-4634-01	BRACKET 取付板		1
08	4131-2586-02	CONTACT 接点		1	26	4131-2588-01	CONTACT 接点		1
09	4131-2587-01	CONTACT 接点		1	27	4131-6828-02	WIRE HARNESS ASSY ワイヤアサシ		1
10	4131-2509-01	GUIDE ガイド		1	28	4131-2584-01	PIN ピン		2
11	4131-2512-01	GEAR ギヤ		1	29	4131-2582-02	CONTACT 接点		1
12	4131-2504-01	GEAR ギヤ		1	30	4131-6826-02	WIRE HARNESS ASSY ワイヤアサシ		1
13	4131-2502-01	GEAR ギヤ		1	31	4131-2581-01	CONTACT 接点		1
14	4131-2511-01	GEAR ギヤ		1					
15	4131-2503-01	GEAR ギヤ		1					
16	4131-2594-01	GEAR ギヤ		1					
17	4131-2535-01	FLANGE フランジ		1					
18	9314-2100-22	MOTOR フラシレスモータ		1					

INDEX	PART NO.	PART NAME	REC	QTY
		MAIN メイン	RP	1
		SFIX		

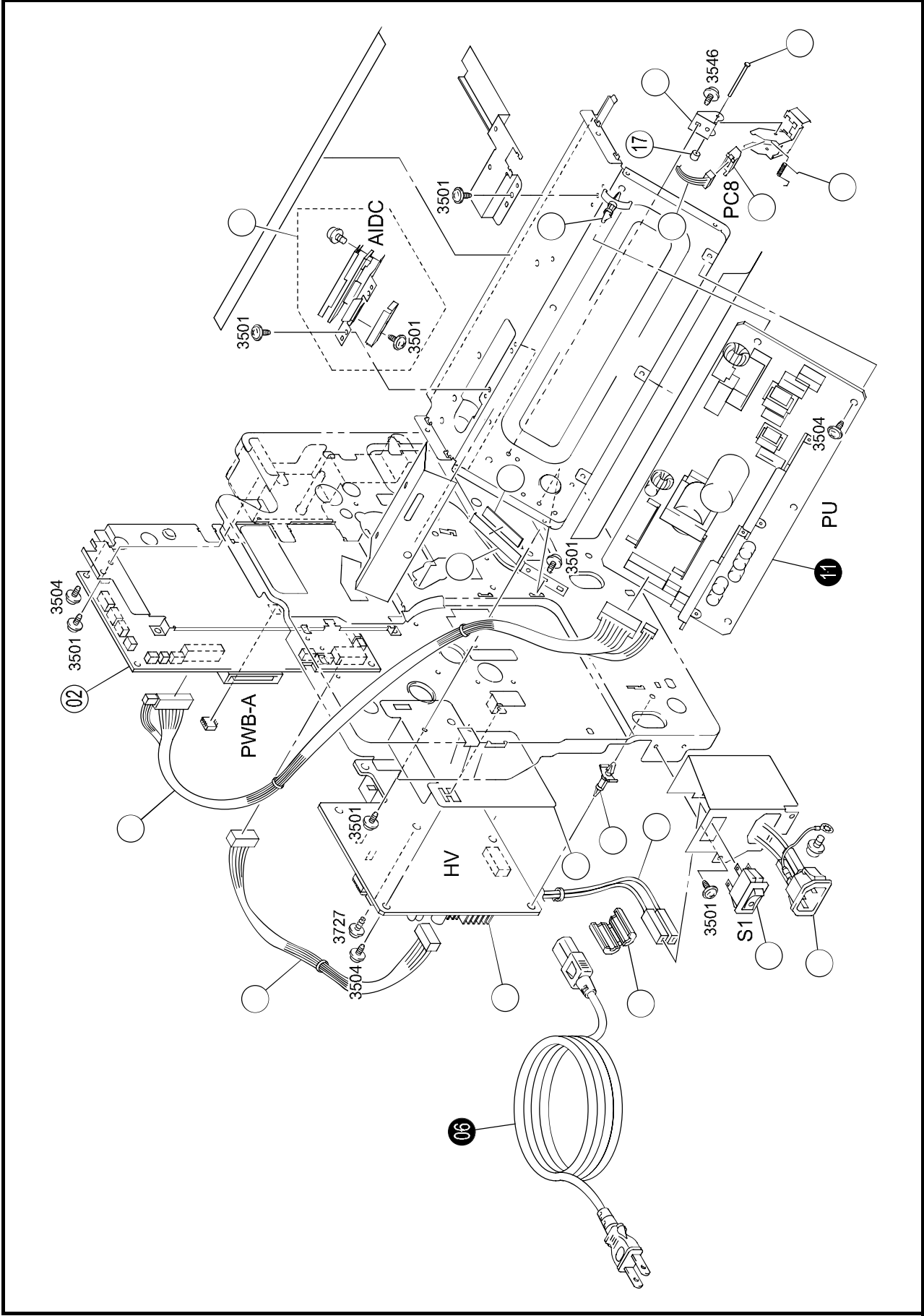

INDEX	PART NO.	PART NAME	REC	QTY	INDEX	PART NO.	PART NAME	REC	QTY
01	4131-0399-01	A/D C.A.S.S.Y	RP	1	21	4131-2052-01	BRAKE ブレーキ材		1
02	4131-0907-01	ENGINE BOARD エンジンボード	RP	1	22	4131-2053-01	PLATE SPRING 板ばね		1
03	4131-6808-01	WIRE HARNESS ASSY		1					
04	4131-6825-01	WIRE HARNESS ASSY		1					
05	4131-6211-05	HV TRANSFORMER 高圧コイル	RP	1					
07	9384-1900-58	PWB SUPPORT 12.7H 基板サポート		2					
08	4131-6802-02	WIRE HARNESS ASSY		1					
09	0993-6303-01	WIRE HARNESS ASSY	RP	1					
10	4131-6801-01	SWITCH スイッチ		1					
12	9335-1100-21	WIRE HARNESS ASSY	RP	1					
13	4131-6824-01	SOLID STATE SWITCH 反射型フォトスイッチ	RP	1					
14	9384-1900-57	WIRE HARNESS ASSY		1					
15	9326-1810-51	PWB SUPPORT 9.53H 基板サポート		3					
16	4131-2312-02	FERRITE CORE フェライトコア		1					
17	1200-2105-05	COVER カバー		1					
18	4131-2340-01	COLLAR カラ		1					
19	4002-3534-02	BRACKET 取付板		1					
20	4131-2341-01	SHAFT シャフト		1					
		TORSION SPRING ねじりコイルばね		1					
INDEX	PART NO.	PART NAME	REC	QTY	INDEX	PART NO.	PART NAME	REC	QTY
06	9381-4100-82	POWER CORD プラグ付電源コード		1					
06	9381-4100-91	POWER CORD プラグ付電源コード		1	011, 012				
06	9381-4101-01	POWER CORD プラグ付電源コード		1	311, 312				
06	9381-4910-21	POWER CORD プラグ付電源コード		1	211, 212				
11	4131-6201-04	POWER SUPPLY 直流安定化電源	RP	1	213				
11	4131-6202-04	POWER SUPPLY 直流安定化電源	RP	1	011, 012, 311, 312				
				1	211, 212, 213				

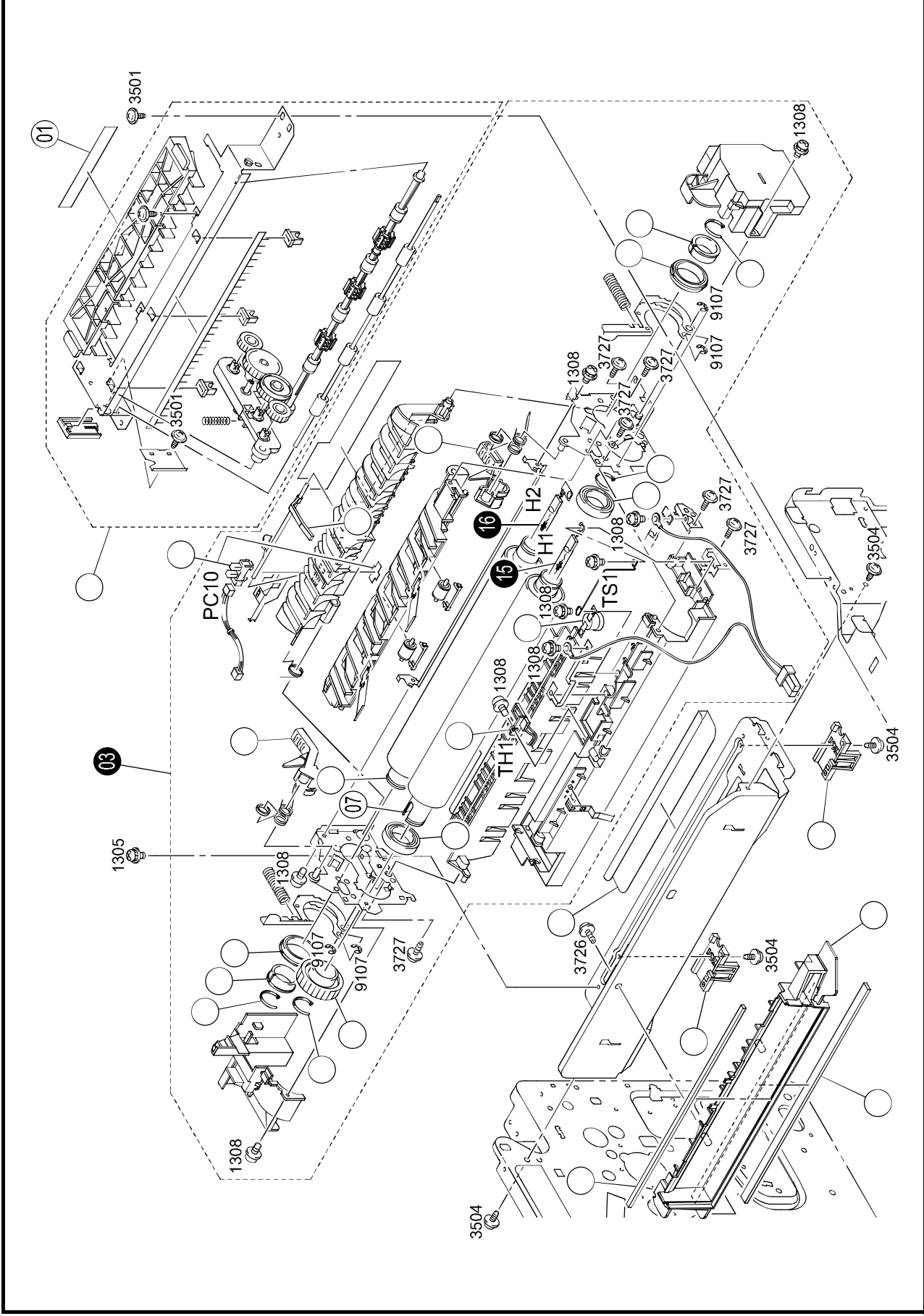

INDEX	PART NO.	PART NAME	REC	QTY	INDEX	PART NO.	PART NAME	REC	QTY
01	4131-3950-01	LABEL ラベル		1	22	4131-5534-03	LEVER レバー		1
02	4131-0385-03	PAPER EXIT ASSY 排紙		1	23	4131-5518-04	ACTUATOR アクチュエータ		1
04	4131-0902-01	PHOTO INTERRUPTER フォトインタラプター		1					
05	4131-5542-03	LEVER レバー		1					
06	4131-5502-01	ROLLER ローラー		1					
07	4131-5501-02	ROLLER ローラー		1					
08	4131-5522-01	BALL BEARING ボールベアリング		2					
09	4131-5523-01	BUSHING 軸受		2					
10	4131-5563-03	RING リング		4					
11	4131-5512-01	GEAR ギア		1					
12	4131-5521-01	BALL BEARING ボールベアリング		2					
13	4131-6703-02	THERMISTOR サーミスタ		1					
14	9334-1100-21	THERMAL SWITCH サーミスタスイッチ		1					
17	4131-2024-01	PROTECTION 保護材		1					
18	4131-1021-01	SEAL シール		1					
19	4131-2031-02	PAWL 爪		2					
20	4131-1004-04	COVER カバー		1					
21	4131-1023-01	SEAL シール		1					
SFIX									
03	4131-0375-04	FUSING UNIT 定着 (100 V)	RP	1	011, 012				
03	4131-0376-04	FUSING UNIT 定着 (120 V)	RP	1	311, 312				
03	4131-0377-04	FUSING UNIT 定着 (230 V)	RP	1	211, 212, 213				
15	4131-6502-01	HALOGEN LAMP ハロゲンランプ		1	311, 312				
15	4131-6504-01	HALOGEN LAMP ハロゲンランプ		1	211, 212, 213				
15	4131-6506-01	HALOGEN LAMP ハロゲンランプ		1	011, 012				
16	4131-6503-02	HALOGEN LAMP ハロゲンランプ		1	311, 312				
16	4131-6505-02	HALOGEN LAMP ハロゲンランプ		1	211, 212, 213				
16	4131-6507-02	HALOGEN LAMP ハロゲンランプ		1	011, 012				
		FUSING 定着							
		FUSING 定着							
		FUSING 定着							
		PRESS 加圧							
		PRESS 加圧							
		PRESS 加圧							

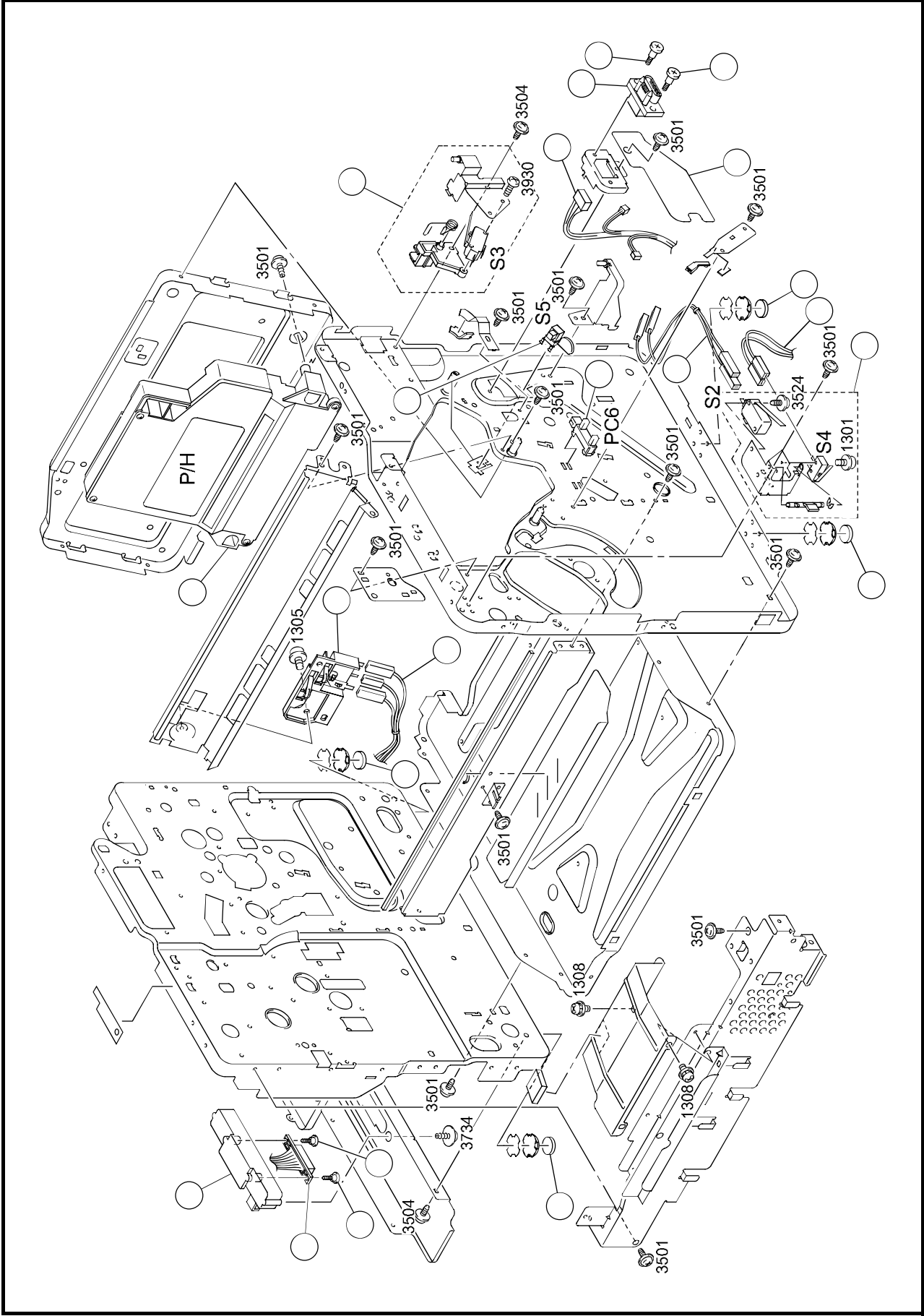

9 PAPER TRANSPORT SECTION

magicolor 2350/2300DL

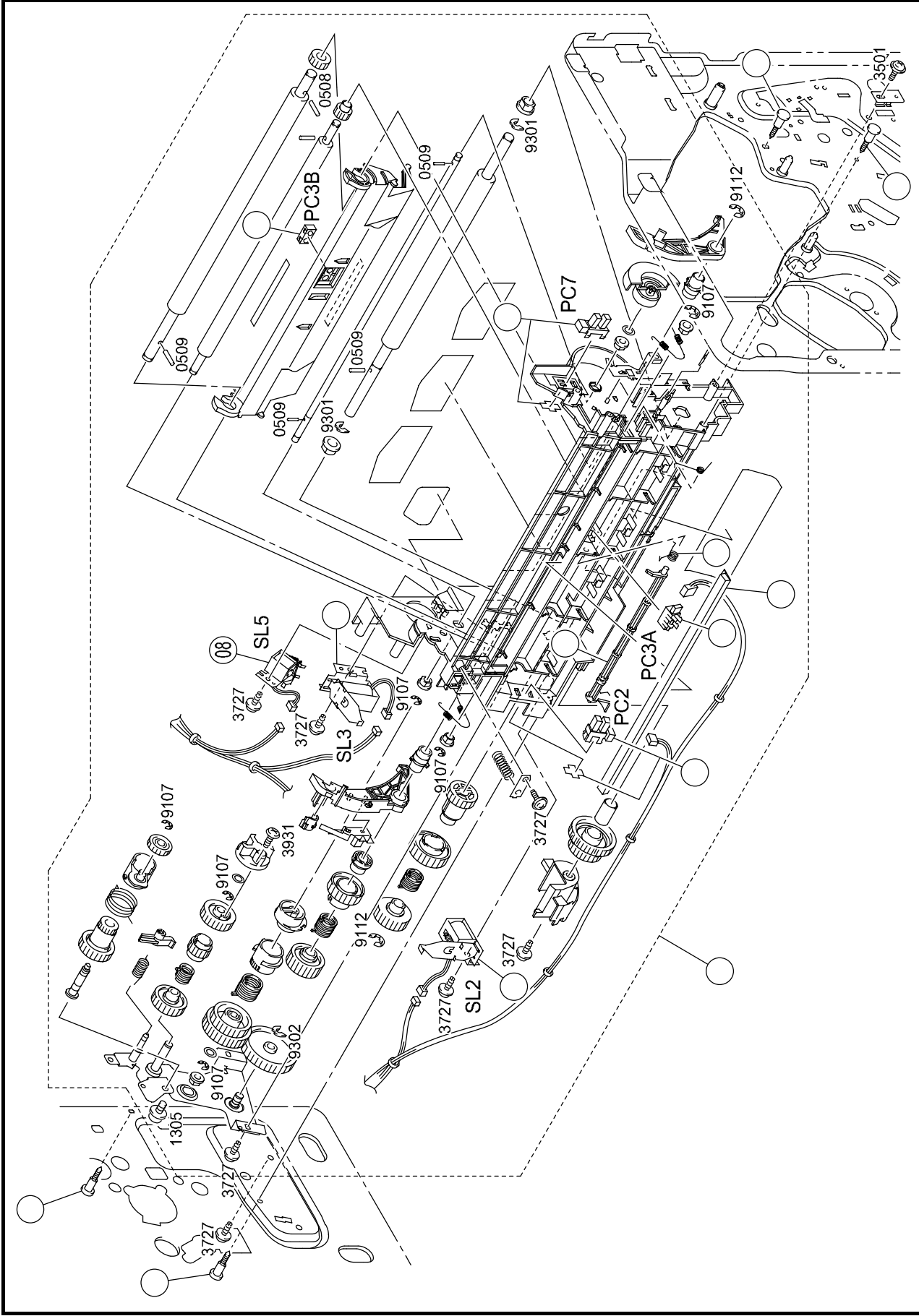

INDEX	PART NO.	PART NAME	REC	QTY	INDEX	PART NO.	PART NAME	REC	QTY
01	4131-3514-01	SHOULDER SCREW 段なし		4					
02	4131-0360-04	TRANSPORT UNIT 搬送	RP	1					
03	4131-3509-02	CLEANING PAD クリーニングパッド		1					
04	4131-3512-01	TORSION SPRING ねじりコイルばね		1					
05	9335-1100-31	SOLID STATE SWITCH 透過型フォトスイッチ		1			OHP (PC3A) OHP 検出 (PC2.7)		
06	4131-0902-01	PHOTO INTERRUPTER フォトインタラプター		2					
07	4131-3511-03	ACTUATOR アクチュエータ		1					
08	9321-2100-41	SOLENOID フラットバーソレノイド		1			IMAGE TRAN. (SL5) 2次駆写圧接 (SL2.3)		
09	9321-2100-51	SOLENOID フラットバーソレノイド		2					
10	9335-1910-21	SOLID STATE SWITCH 透過型フォトスイッチ		1					
INDEX	PART NO.	PART NAME	REC	QTY					
							SFIX		

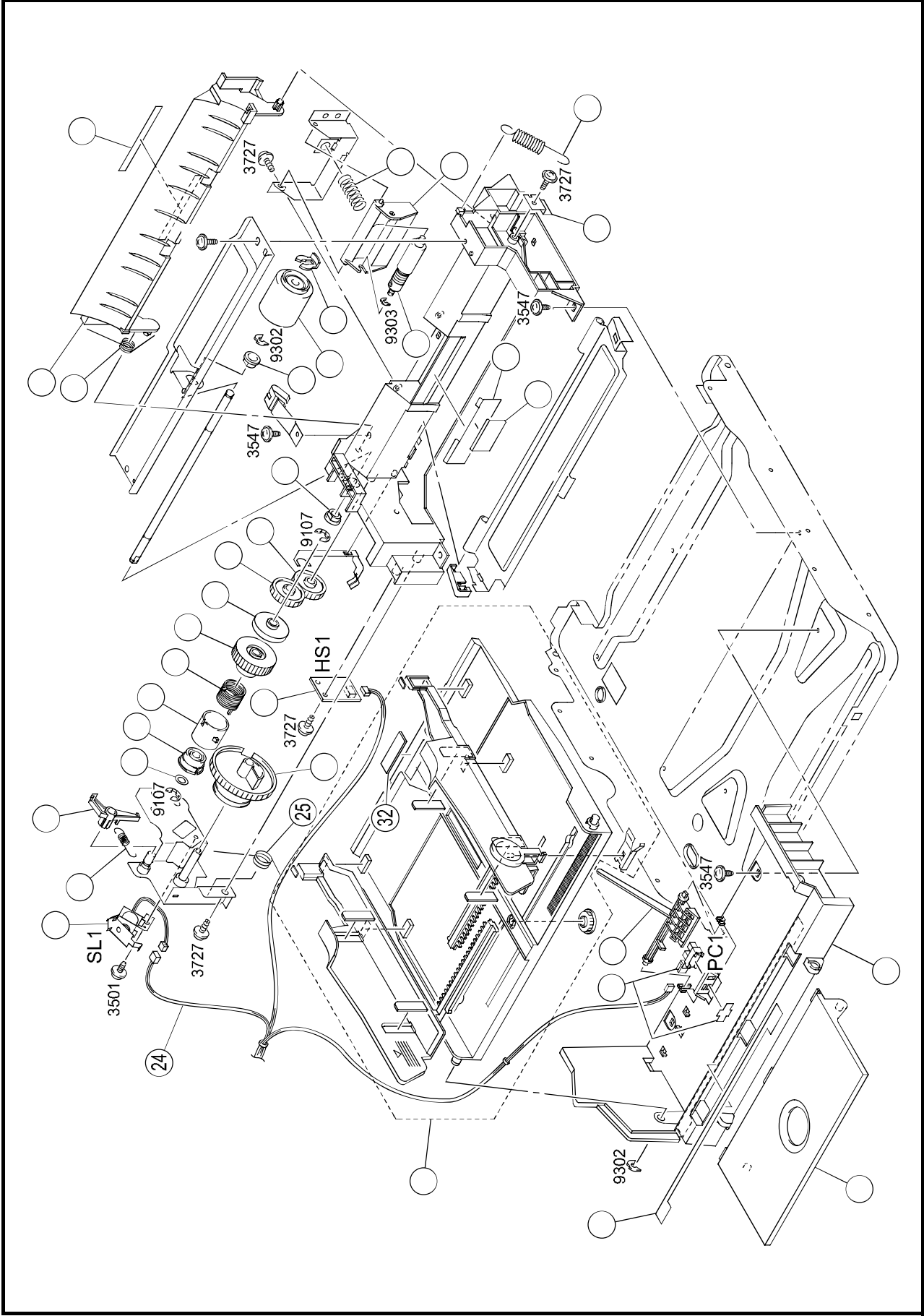

INDEX	PART NO.	PART NAME	REC	QTY	INDEX	PART NO.	PART NAME	REC	QTY	INDEX	PART NO.	PART NAME	REC	QTY
01	4131-7419-01	LABEL ラベル		1	19	4131-3007-02	DRUM ドラム		1	20	1200-1342-05	WASHER ワッシャー	RP	1
02	4131-3010-03	GUIDE ガイド		1	21	4131-3038-01	LEVER レバー		1	22	4131-3040-01	TENSION SPRING ねじりコイルばね		1
03	4131-3054-02	PRESSURE SPRING 圧縮コイルばね		1	23	9321-2100-41	SOLENOID ソレノイド		1	24	4131-6818-03	WIRE HARNESS ASSY ワイヤハーネス	RP	1
04	4131-3053-02	HOLDER ホルダ		1	25	4131-3039-03	TORSION SPRING ねじりコイルばね		1	26	4131-3035-02	GEAR ギヤ		1
05	4131-3033-03	TENSION SPRING 引張コイルばね		1	27	4131-0430-03	LIFTING PLATE ASSY 昇上板 ASSY		1	28	4131-3042-03	ACTUATOR アクチュエータ		1
06	4131-3043-01	STOPPER ストッパ		1	29	4131-0902-01	PHOTO INTERLUPTER フォトインタラプター		1	30	4131-7421-02	LABEL ラベル	RP	1
07	4131-3057-02	STOP RING 止め輪		1	31	4131-3028-05	COVER カバー		1	32	1164-3064-01	FRICITION SHEET 摩擦紙		1
08	4131-3056-01	GUIDE PLATE ガイド板		1	33	4131-3011-01	TORSION SPRING ねじりコイルばね		1	34	4131-3021-04	TRAY トレイ		1
09	4658-0151-01	ROLLER ASSY ローラ ASSY	RP	1			SEPARATOR サハキ		1					
10	4142-3217-01	STOP RING 止め輪		1			TAKE-UP 給紙		1					
11	4131-3001-01	ROLLER ローラ	RP	1			TEMPERAT. 湿度		1					
12	4131-3003-01	BUSHING 軸受		2					2					
13	9372-5100-12	HUMIDITY CONVERSION EL. 湿度変換素子		1					1					
14	4131-3080-01	GEAR ギヤ		2					2					
15	4131-3008-01	ROLL ころ		1					1					
16	4131-3004-02	GEAR ギヤ	RP	1					1					
17	4131-3006-01	TORSION SPRING ねじりコイルばね	RP	1					1					
18	4131-3005-01	WATCHET ワチエント	RP	1					1					
INDEX	PART NO.	PART NAME	REC	QTY	SFIX									

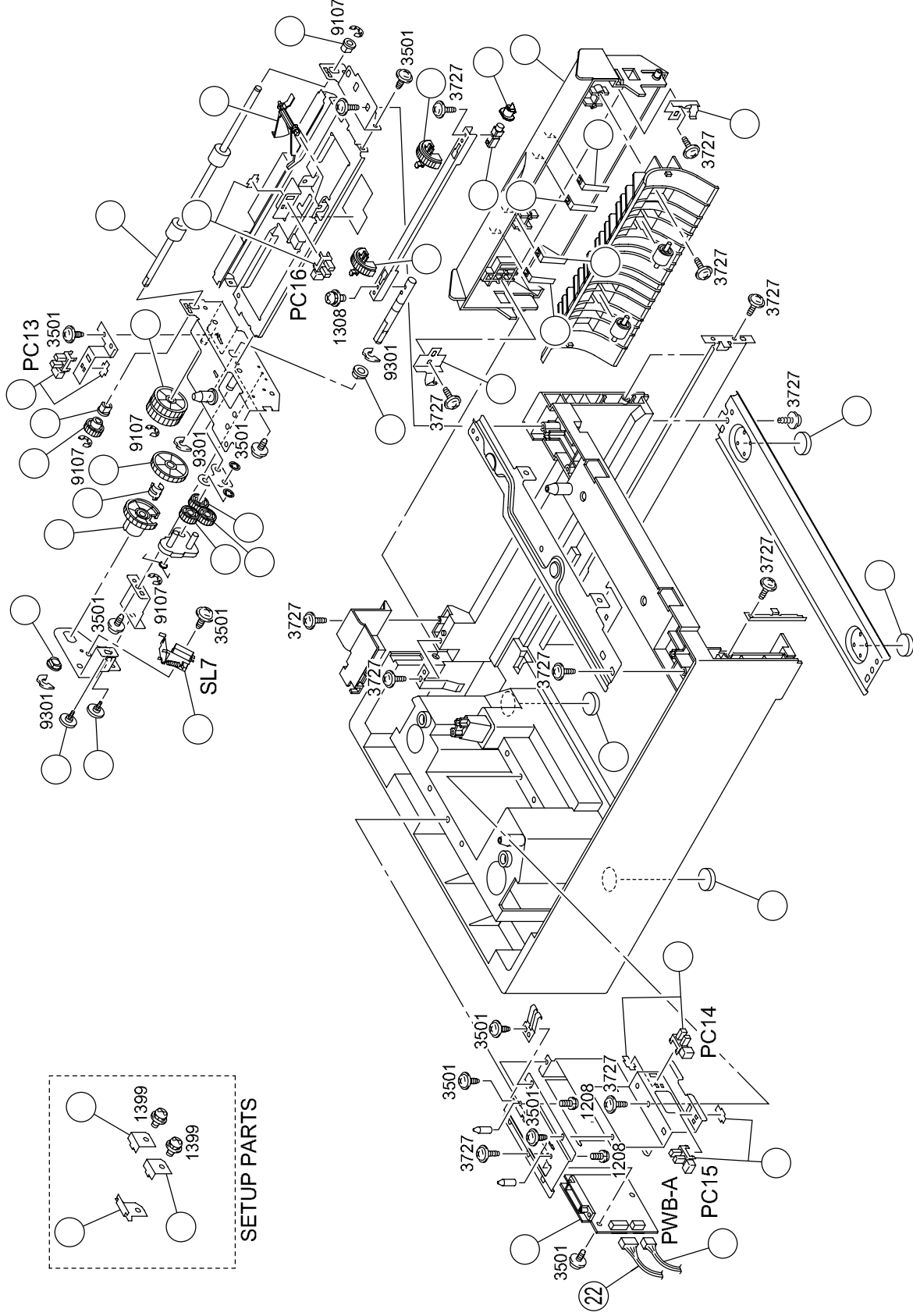
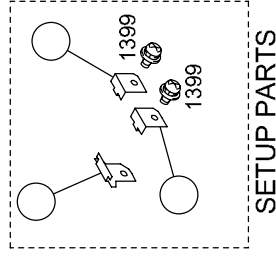

INDEX	PART NO.	PART NAME	REC	QTY	INDEX	PART NO.	PART NAME	REC	QTY	INDEX	PART NO.	PART NAME	REC	QTY
01	4120-4039-02	BUSHING 軸受		2	19	4574-3118-04	PLATE SPRING 板ばね		2					
02	4574-3221-03	ACTUATOR アクチュエータ		1	20	4131-2016-01	RUBBER FOOT ゴム足		4					
03	4131-0902-01	PHOTO INTERUPUTER フォトインタラプター	RP	4	21	4574-6801-02	WIRE HARNESS ASSY ハーネスアッシー		1					
04	4574-3207-01	ROLLER ローラー		1	22	4574-6802-02	WIRE HARNESS ASSY ハーネスアッシー		1					
05	4574-3205-01	GEAR ギヤ		1	23	4574-0101-01	PWB ASSY 基板アッシー	CONTROL (PWB-A)	1					
06	4574-3208-01	GEAR ギヤ		1	24	4574-3401-03	PORTER 荷役機	FRONT 前	2					
07	4574-3223-02	GEAR ギヤ		1	25	4574-3402-02	PORTER 荷役機	REAR 後	1					
08	4574-3228-01	PLATE SPRING 板ばね		1										
09	4574-3224-04	GEAR ギヤ		1										
10	4131-3532-02	BUSHING 軸受		2										
11	0990-3214-01	SHOULDER SCREW タネンネジ		2										
12	9321-2100-41	SOLENOID ソレノイド		1			TAKE-UP 給紙	RP	3					
13	4574-3218-01	GEAR ギヤ		2			TAKE-UP 給紙	RP	2					
14	4142-0212-02	ROLLER ASSY ローラアッシー		1					1					
15	4574-3225-02	BUSHING 軸受		1					1					
16	4574-3217-01	JOINT ジョイント		1					1					
17	4574-3107-03	COVER カバー		1					1					
18	4574-3216-01	PLATE SPRING 板ばね		4					4					
INDEX	PART NO.	PART NAME	REC	QTY	INDEX	PART NO.	PART NAME	REC	QTY	INDEX	PART NO.	PART NAME	REC	QTY

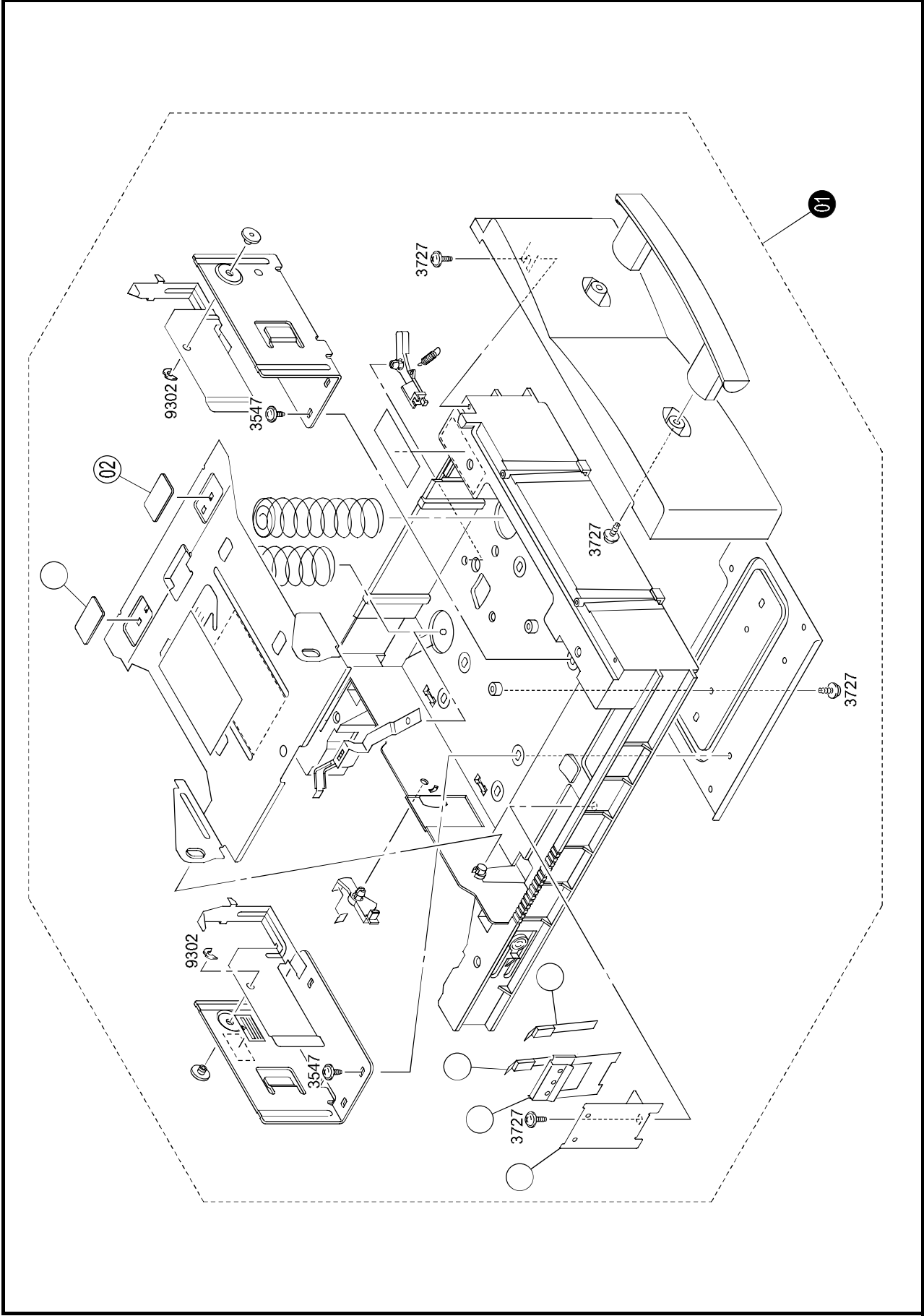



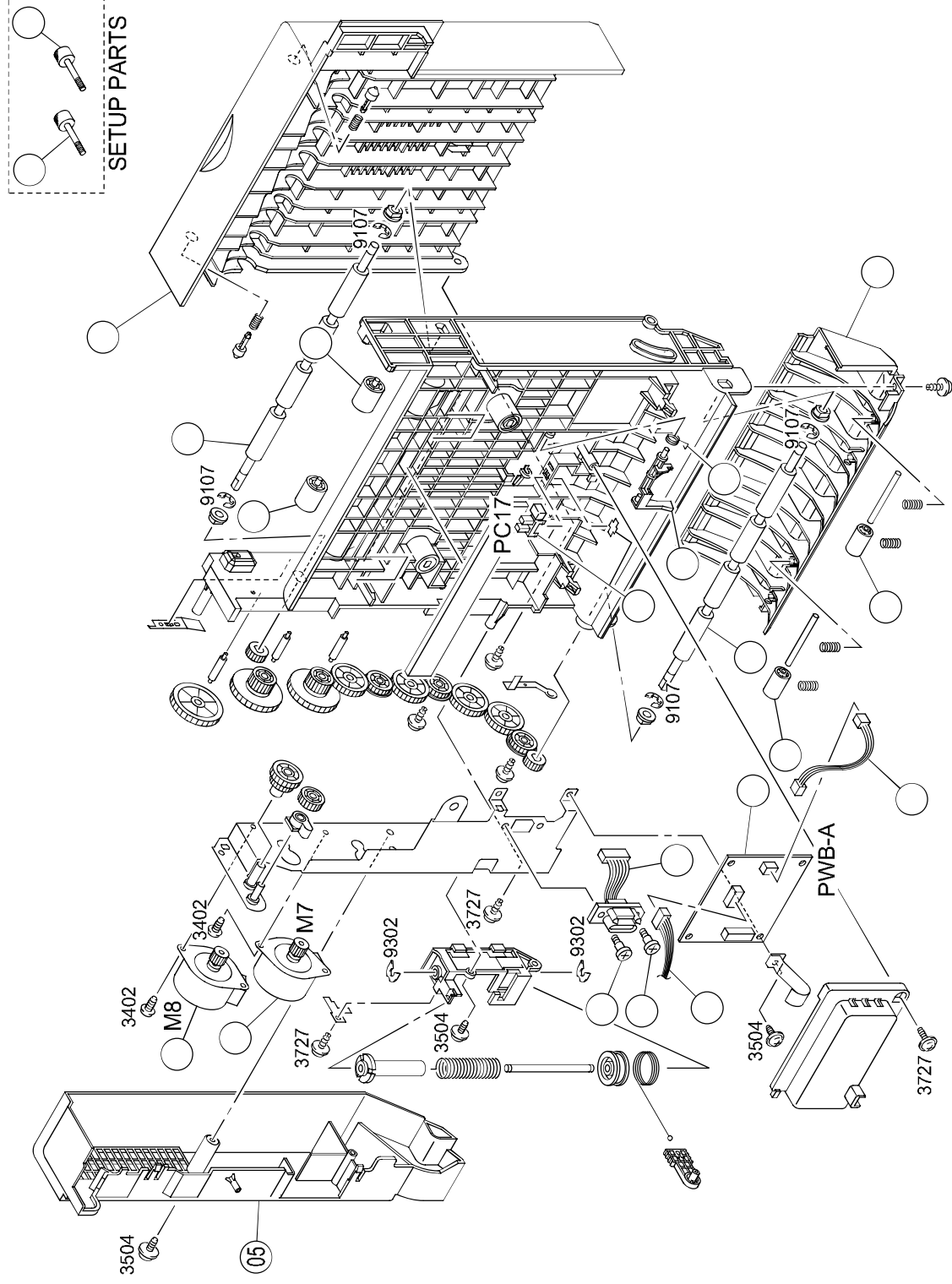







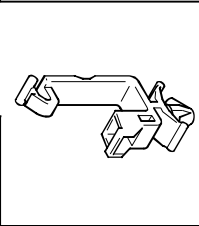
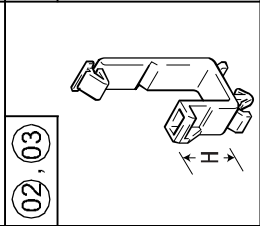
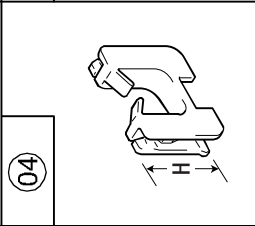
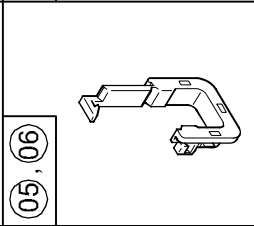
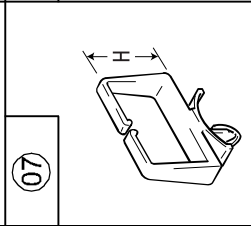

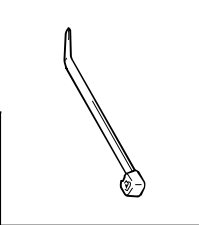
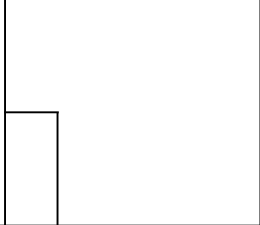
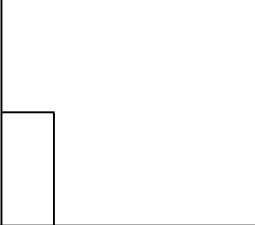
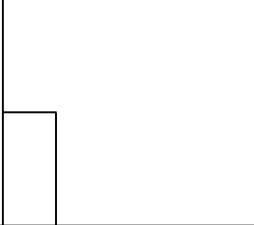
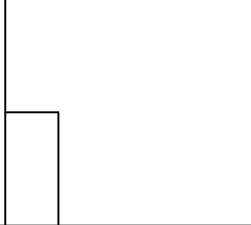

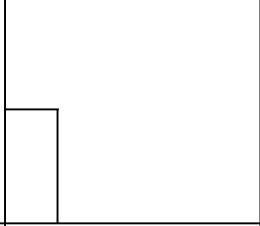
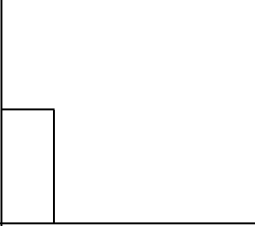
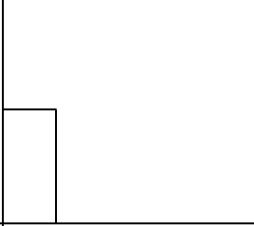
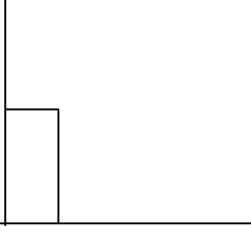

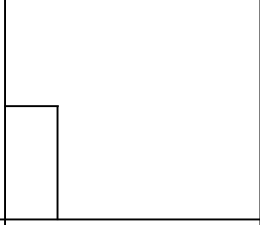
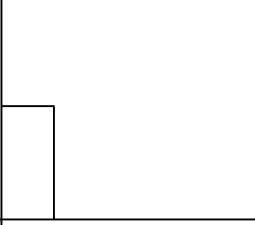
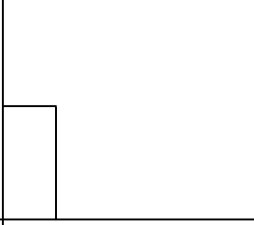
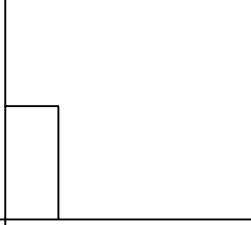
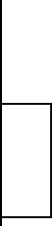

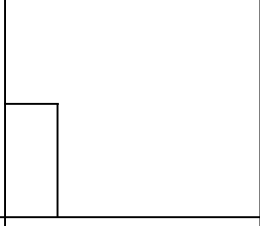
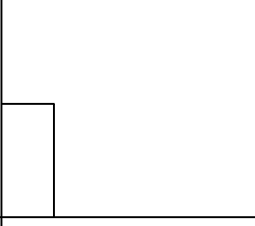
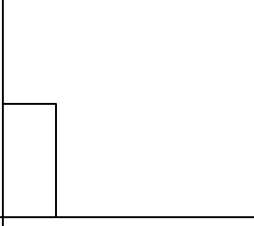
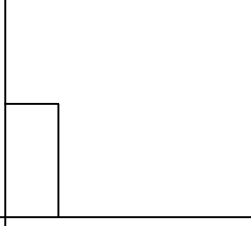
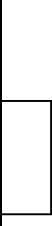
INDEX	PART NO.	PART NAME	REC	QTY	INDEX	PART NO.	PART NAME	REC	QTY	INDEX	PART NO.	PART NAME	REC	QTY
02	4120-3116-01	SEPARATOR PAD はばき材	RP	2										
03	4574-3315-02	MEMBER 伸入材		2										
04	4574-3316-03	PLATE SPRING 板ばね		1										
05	4574-3306-02	REGULATING PLATE 規制板		1										
INDEX														
01	4574-0311-03	CASSETTE ASSY カセット Assy		1					1		011, 012, 211, 212, 213			
01	4574-0312-03	CASSETTE ASSY カセット Assy		1					1		311, 312			

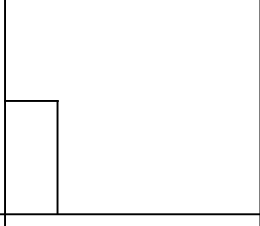
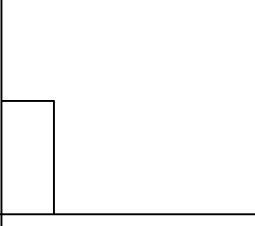
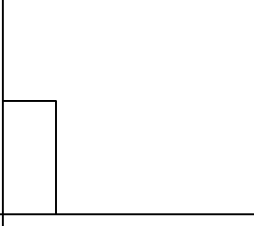
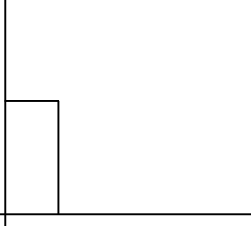

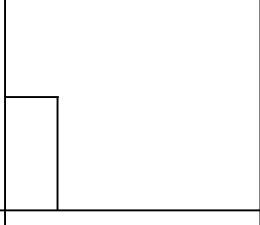
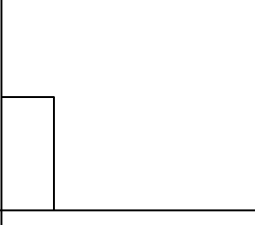
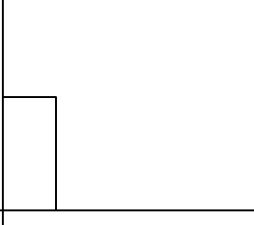
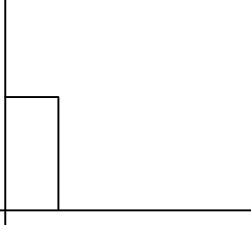
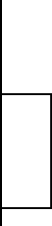
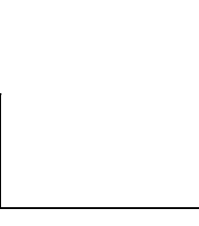
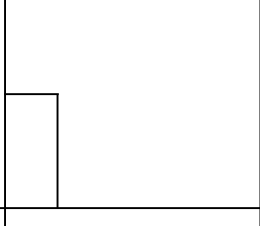
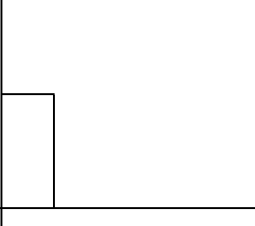
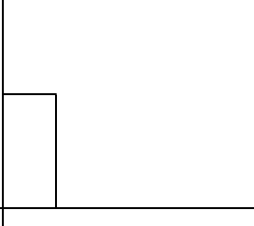
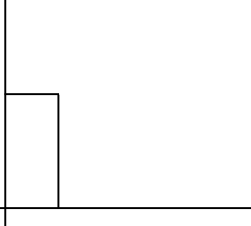
INDEX	PART NO.	PART NAME	REC	QTY	INDEX	PART NO.	PART NAME	REC	QTY	INDEX	PART NO.	PART NAME	REC	QTY
01	4575-3702-04	COVER カバー		1										
02	4575-3722-01	ROLLER ローラー		2										
03	4143-3720-01	ROLL ロール		2										
04	9314-1200-11	MOTOR モーター		2										
05	4575-3712-02	REAR COVER 後カバー	RP	1			(M7.8)							
06	4575-6803-02	WIRE HARNESS ASSY ワイヤーハーネス		1										
07	4143-6801-01	WIRE HARNESS ASSY ワイヤーハーネス		1										
08	4575-6802-01	WIRE HARNESS ASSY ワイヤーハーネス		1										
09	4575-3728-01	WIRE HARNESS ASSY ワイヤーハーネス		2										
10	4575-0101-02	PWB ASSY 基板	RP	1			CONTROL (PWB-A) 制御							
11	4131-0902-01	PHOTO INTERLUPTER フォトインタラプター	RP	1			TRANSPORT (PC17) 搬送							
12	4575-3706-01	ACTUATOR アクチュエーター		1										
13	4143-3707-02	TORSION SPRING ねじりコイルばね		1										
14	4575-3709-03	GUIDE PLATE ガイド板		1										
15	0990-2064-01	SHOULDER SCREW 段ねじ		2										
16	4575-3708-01	SHOULDER SCREW 段ねじ		2										
INDEX	PART NO.	PART NAME	REC	QTY										
														SFIX

14 WIRING ACCESSORIES AND JIGS

magicolor 2350/2300DL

08

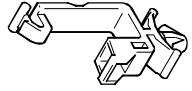

02, 03

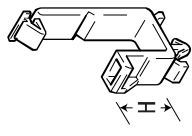

04

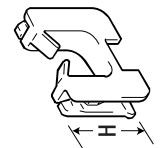

05, 06

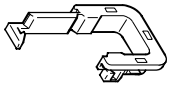



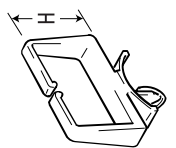







07



INDEX	PART NO.	PART NAME	REC	QTY	INDEX	PART NO.	PART NAME	REC	QTY
01	9384-1100-91	WIRING SADDLE ワイヤーストル		31					
02	9384-1921-11	WIRING SADDLE 9.2H ワイヤーストル		5					
03	9384-1921-21	WIRING SADDLE 15.2H ワイヤーストル		3					
04	9384-2010-21	EDGE COVER 8.5H エッジカバー		7					
05	9384-2910-21	EDGE COVER エッジカバー		1					
06	9384-2910-31	EDGE COVER エッジカバー		3					
07	9384-1310-81	WIRING SADDLE 6.4H ワイヤーストル		1					
08	9384-1311-11	CABLE TIE 104L ケーブルタイ		1					
INDEX	PART NO.	PART NAME	REC	QTY			SFIX		

15 SCREWS AND WASHERS

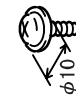
magicolor 2350/2300DL

INDEX	PART NO.	PART NAME	ILLUST	INDEX	PART NO.	PART NAME	ILLUST	INDEX	PART NO.	PART NAME	ILLUST
0502	9752-3012-50	PIN		8301	9712-0300-13	WASHER					
0508	9752-2010-50			9107	9721-0400-01	RETAINING RING					
0509	9752-2012-50			9109	9721-0500-01						
1136	9642-0306-01	9112	9721-0600-01								
1208	9644-0306-13	SCREW		9301	1066-1151-01	RETAINING RING					
1301	9646-0210-13	SCREW		9302	4425-3001-01						
1305	9646-0306-13			9303	4425-3002-01						
1308	9646-0308-13										
1318	9646-0408-13										
1399	9646-0408-14										
2706	9654-0408-14	SCREW									
3402	9733-0306-13	TAPPING SCREW									
3501	9735-0306-13	TAPPING SCREW									
3503	9735-0308-07										
3504	9735-0308-13										
3524	9735-0316-13										
3541	9735-0308-14										
3544	9735-0306-14										
3546	4106-2063-01										
3547	4154-3804-01										
3548	9735-0330-13										
3726	9739-0408-14			TAPPING SCREW							
3727	9739-0308-14										
3734	1250-2301-01										
3930	9742-0318-13	SCREW									
3931	9742-0310-14										
3932	9749-1740-07										

